









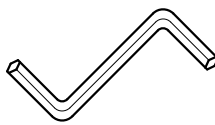

Бюро Деос



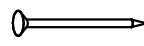
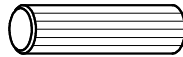

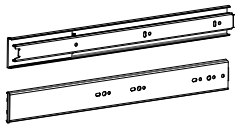
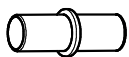
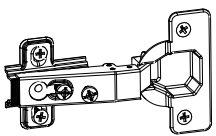

 Ø6,3x50 mm A1 x 34	 Ø12 mm A2 x 34	 4 mm A3 x 1	 Ø4x16 mm D1 x 44	 Ø4,2x25 mm D2 x 8
 Ø4x30 mm D3 x 6	 Ø1,6x20 mm F x 91	 Ø8x36 mm G x 55	 H x 4	 K x 3
 Ø5x16 mm L x 4	 M1 x 2	 Ø15 mm N x 7	 50g R x 1	

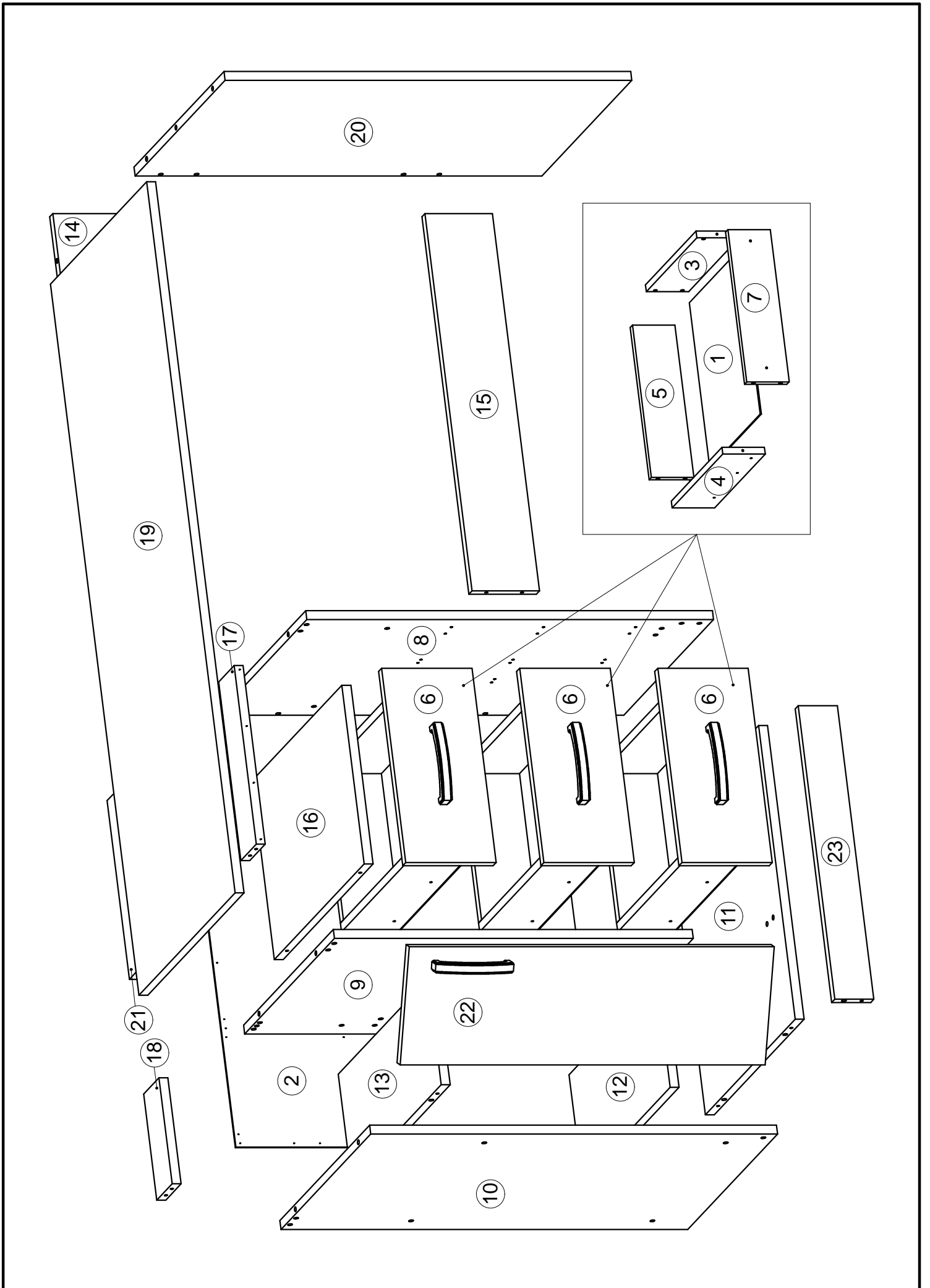

Box 1/3

292x398x3 mm

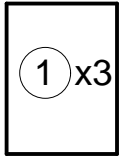

657x556x3 mm

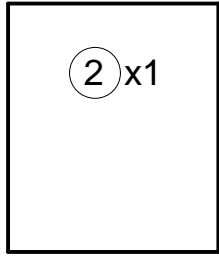

729x470x16 mm

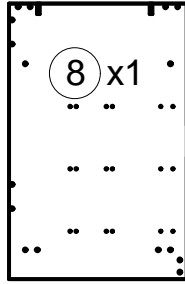

643x470x16 mm

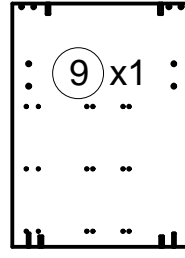

729x470x16 mm

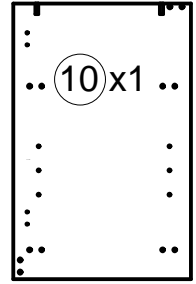

190x80x16 mm

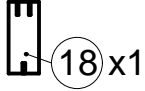

Fittings & Tools

526x470x16 mm

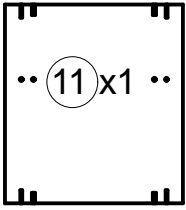

190x460x16 mm

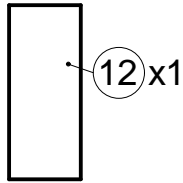

190x470x16 mm

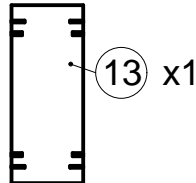

150x676x16 mm

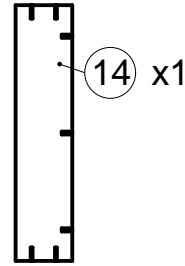

120x676x16 mm

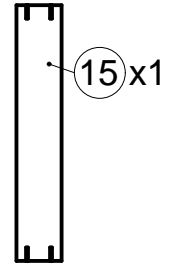

320x470x16 mm

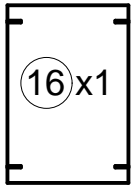

729x470x16 mm

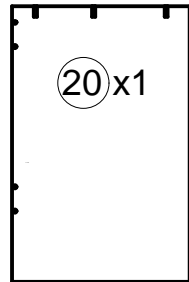

80x320x16 mm

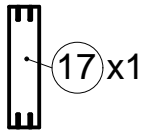

320x80x16 mm

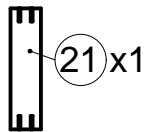

Box 2/3

1270x500x16 mm

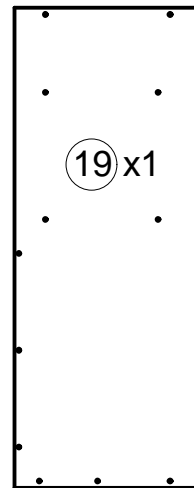

400x100x16 mm

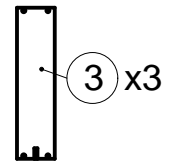

400x100x16 mm

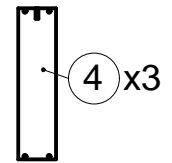

262x100x16 mm

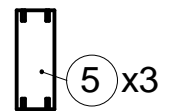

161x347x16 mm

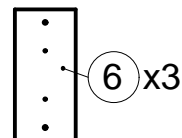

262x100x16 mm

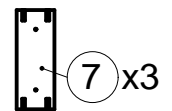

Box 3/3

653x203x16 mm

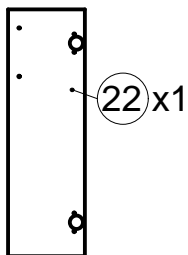

70x526x16 mm

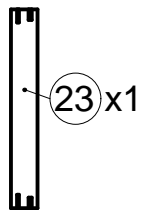

1

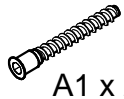

A1 x 2



A2 x 2



A3 x 1



G x 2

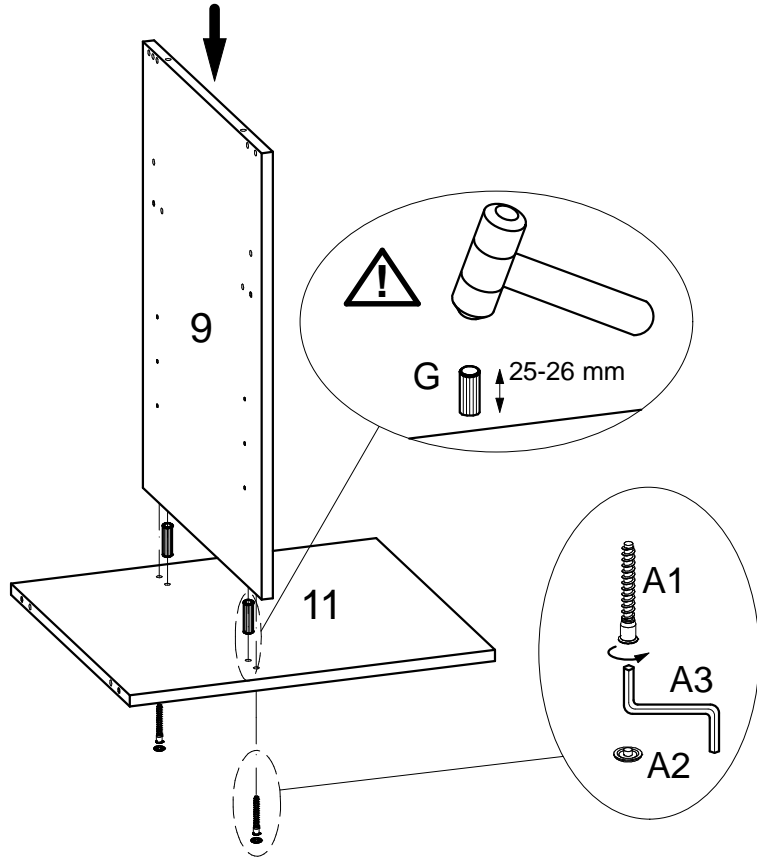
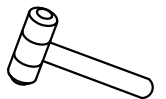

2

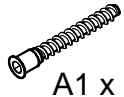

A1 x 8



A2 x 8



A3 x 1

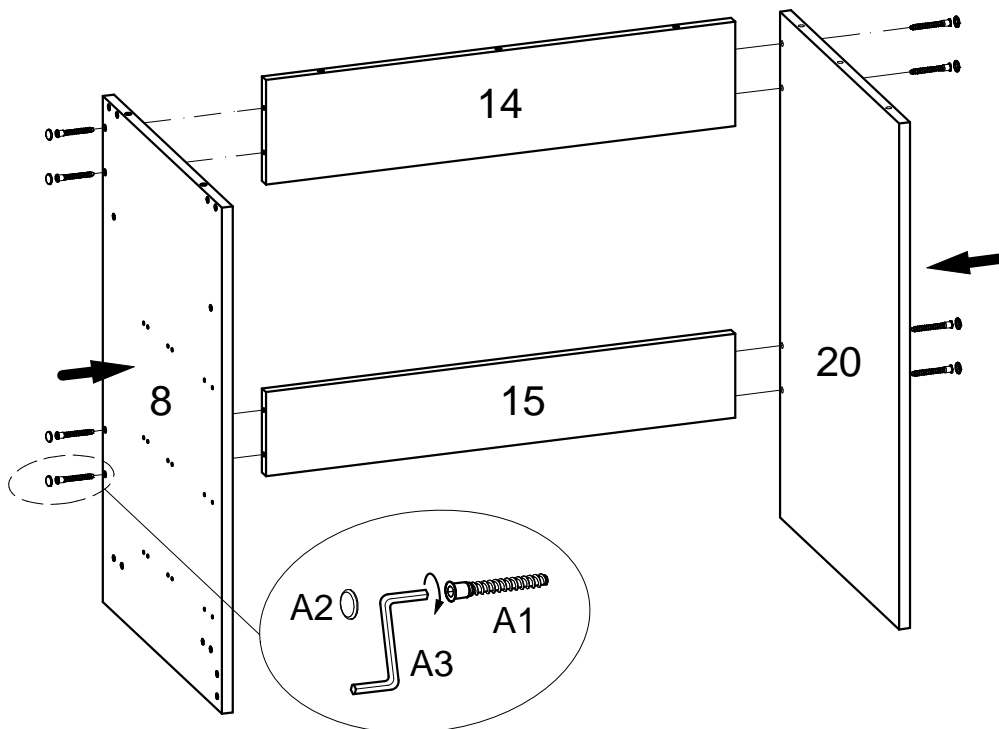

3

- A1 x 24
- A2 x 24
- A3 x 1
- D1 x 18
- K.1 x 3
- K.2 x 3
- G x 11

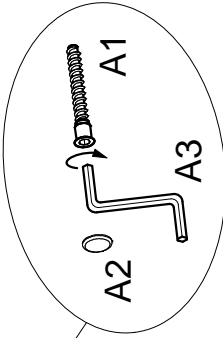
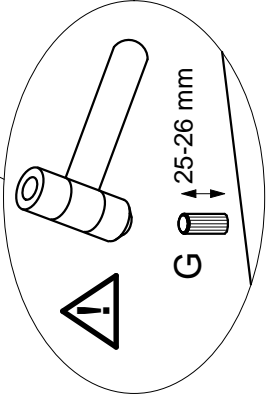
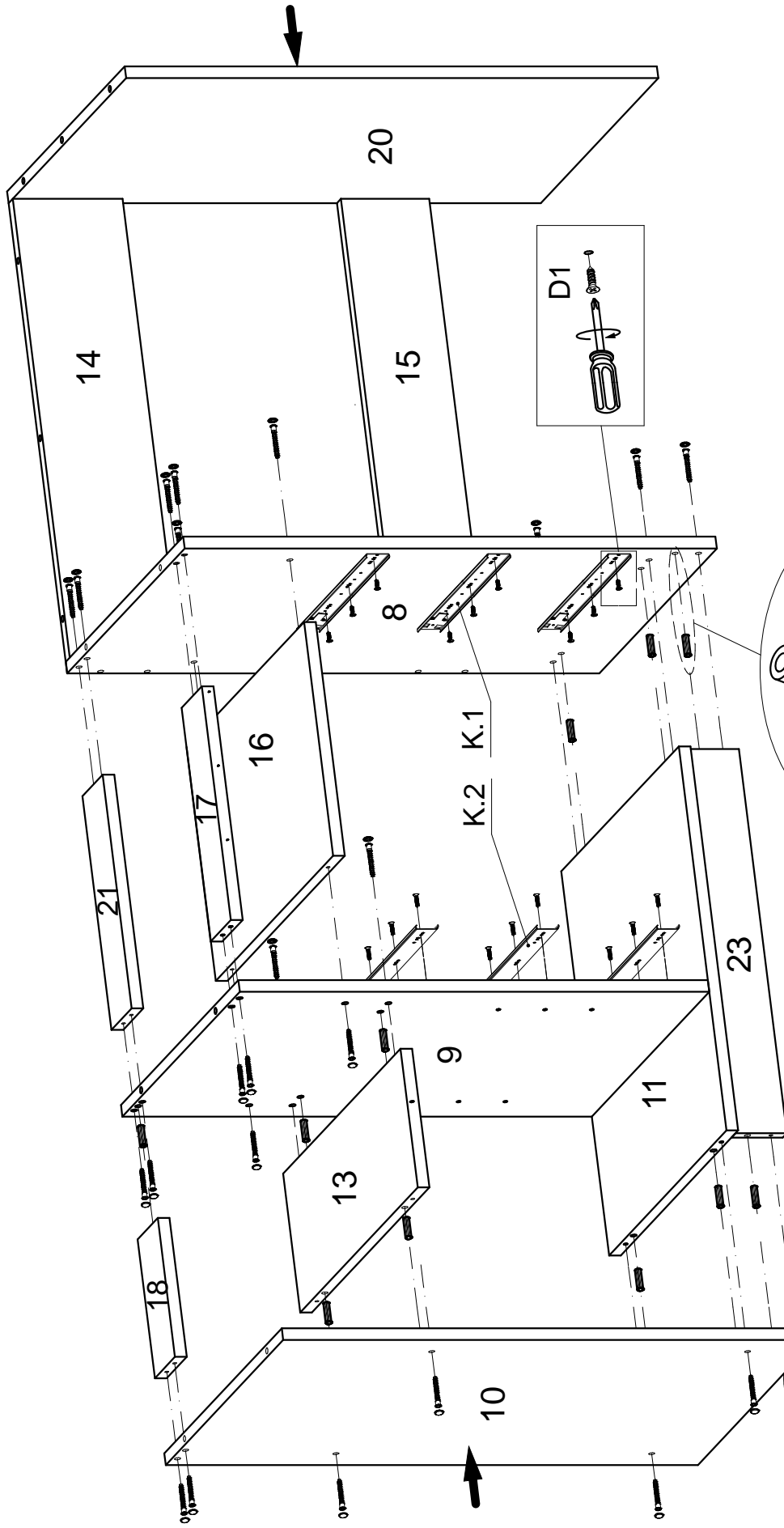
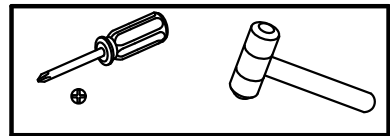

4

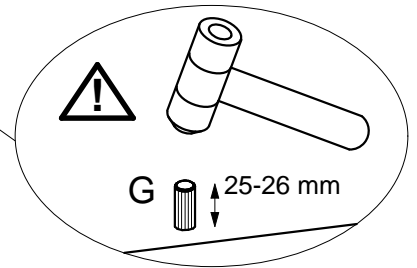
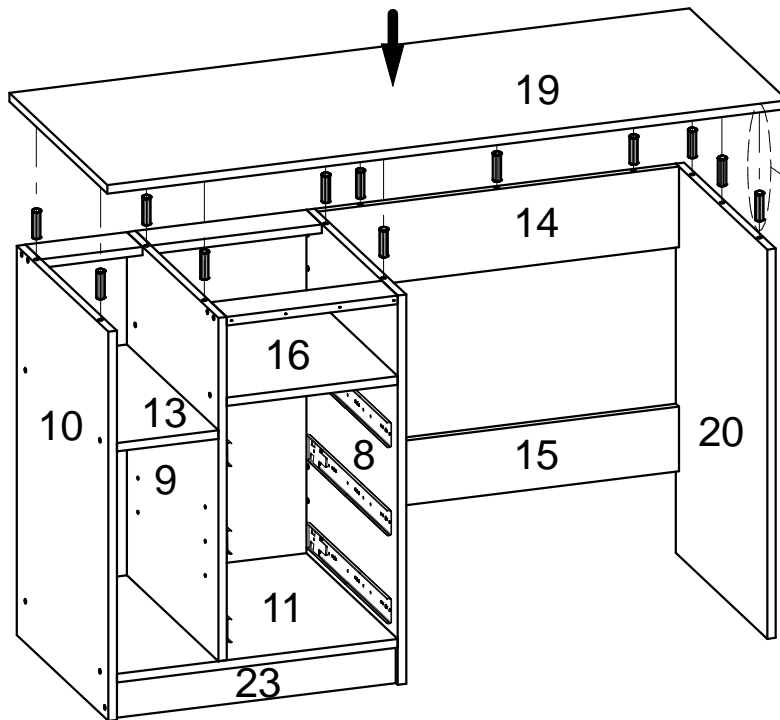
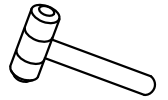
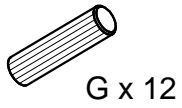

5

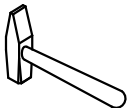
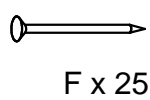

! $XX=YY=90^\circ$

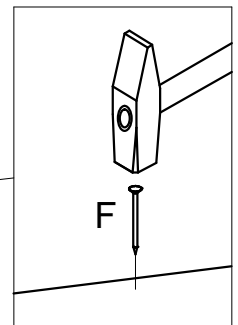
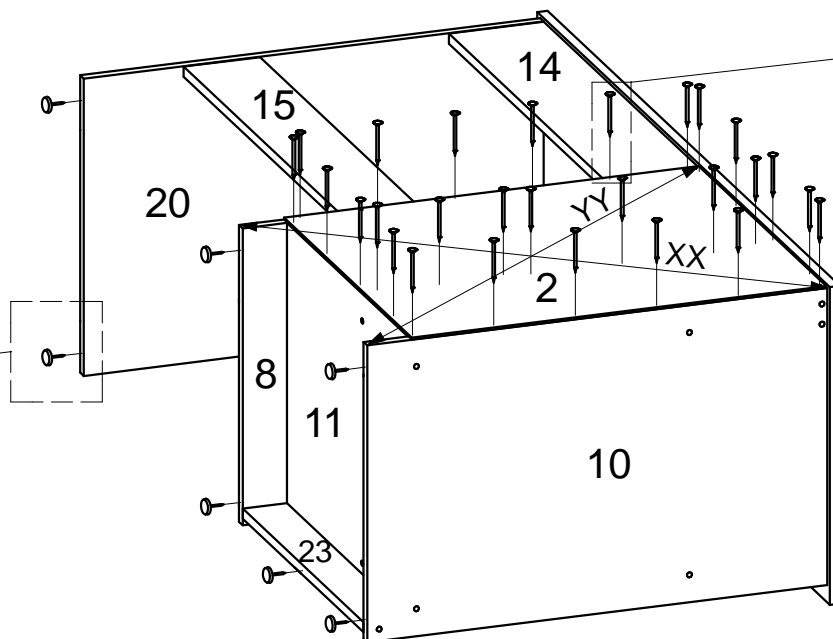
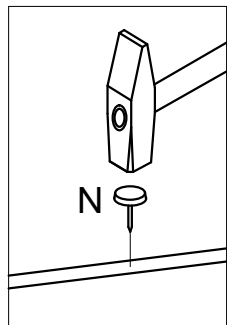

6

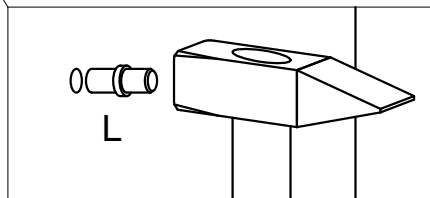
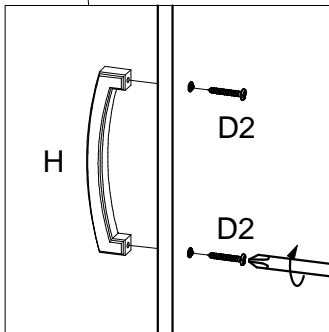
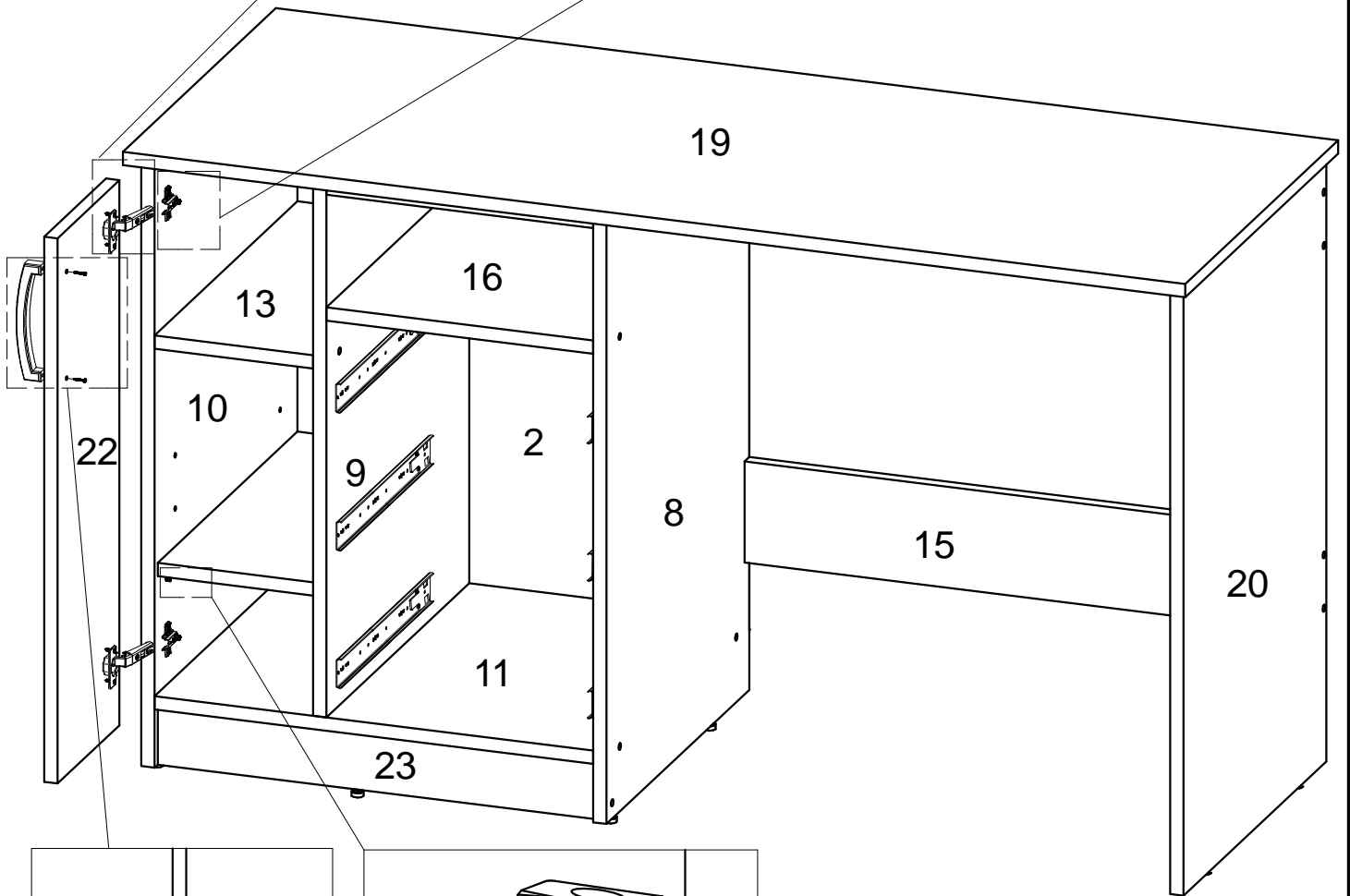
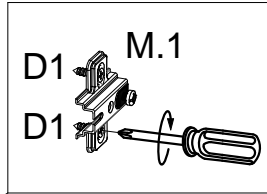
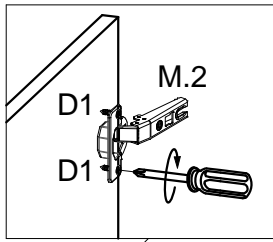

7

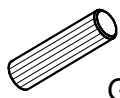

G x 24



R x 1

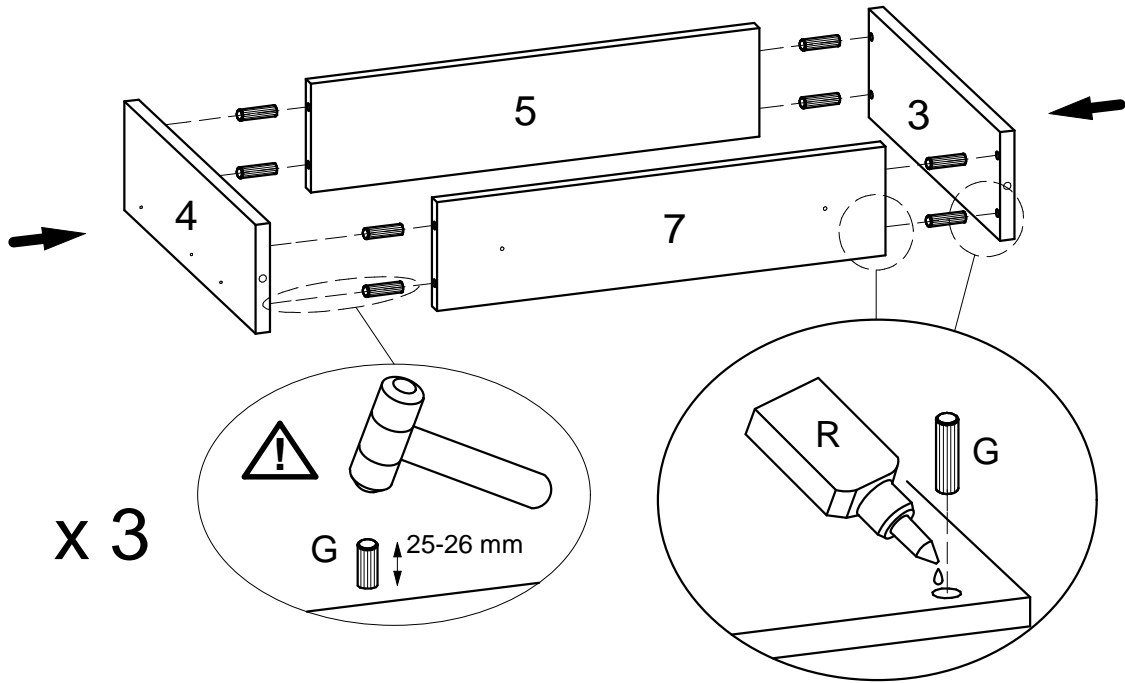
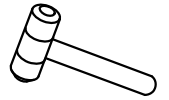

8

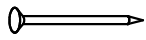

F x 66

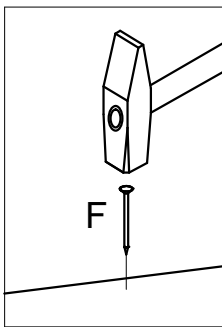
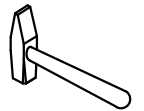

! $XX=YY \cong 90^\circ$

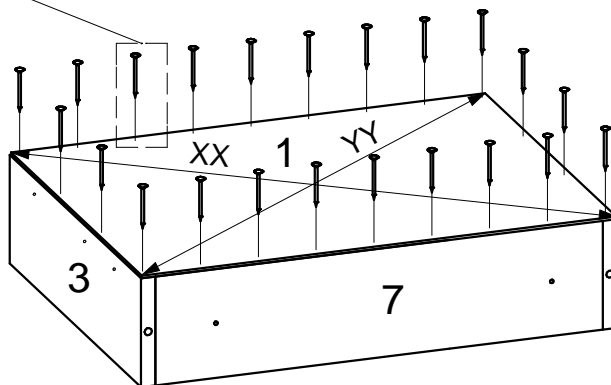

x 3

9



D1 x 18



K.3 x 3



K.4 x 3

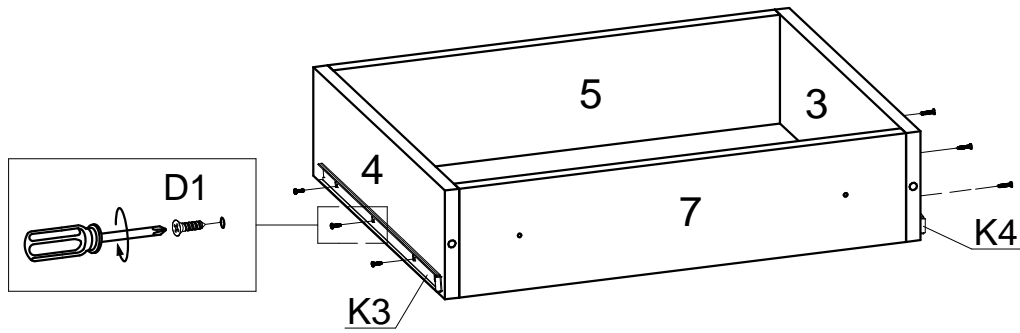
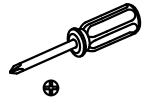

x 3

10

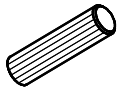

G x 6

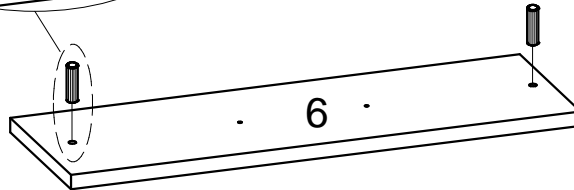
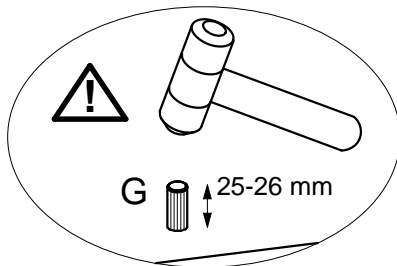
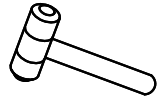

x 3

11



D2 x 6

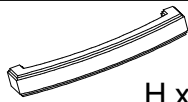

H x 3

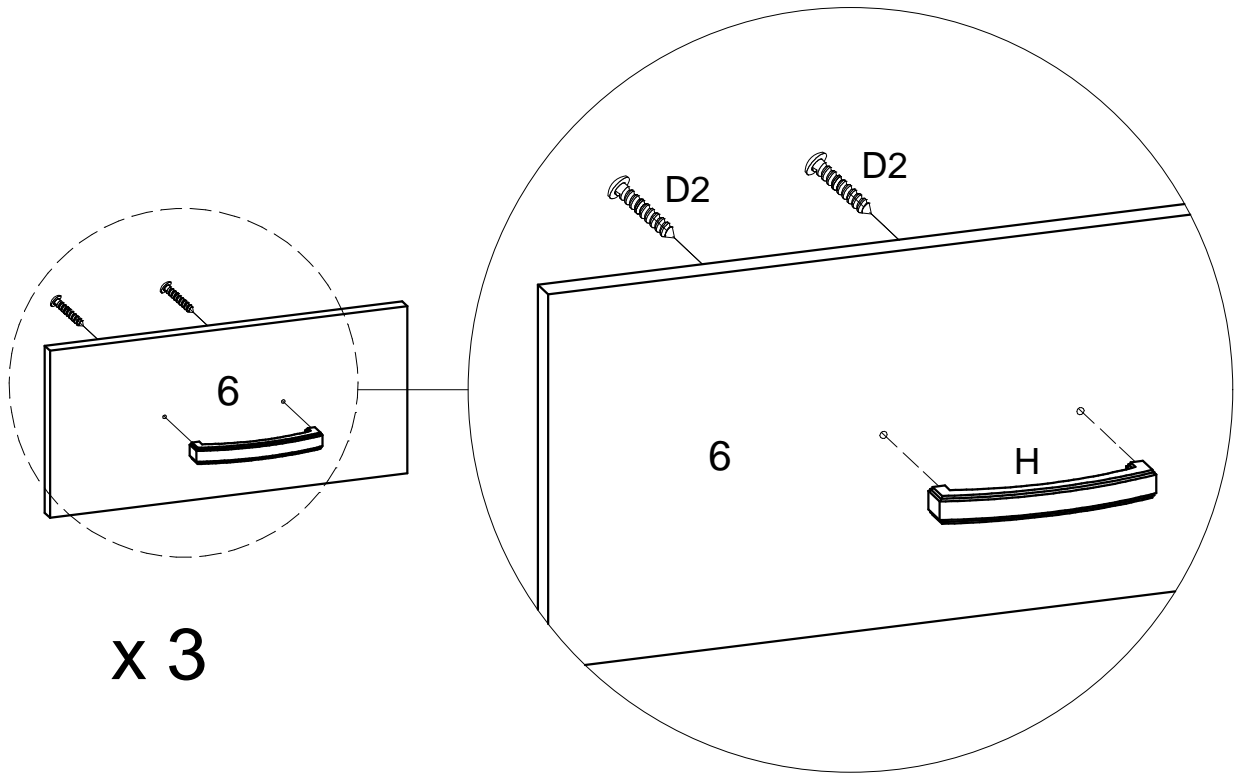
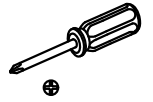

x 3

12



D3 x 6

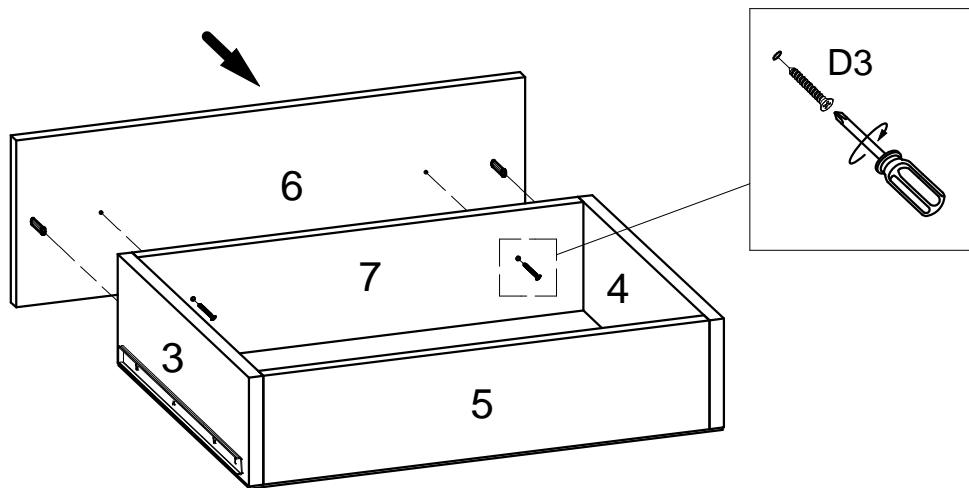
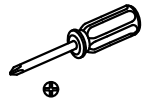

x 3

13

